

ONTOLOGICAL SYNTHESIS OF STRATEGIES FOR MARINE CATASTROPHES CONTROL IN EMERGENCIES

Bondarev Vitaly Alexandrovich¹, Doctor of technical sciences, associate professor

e-mail: dekanat_swf@bga.gazinter.net

Volkogon Vladimir Alekseevich², Candidate of economic sciences, associate professor

e-mail: rector@klgtu.ru

Kovalishin Pavel Yuryievich¹, Candidate of linguistic sciences, associate professor

pavelkovalishinkaliningrad@mail.ru

Nechaev Yury Ivanovich², Doctor of technical sciences, professor

e-mail: dekanat_swf@bga.gazinter.net

1. Baltic Fishing Fleet State Academy

Molodezhnaya, 6 Kaliningrad 236035, Russian Federation

2. Kaliningrad State Technical University

Sovetskiy prospect, 1. Kaliningrad 236029, Russian Federation

Abstract. The ontological synthesis of strategies for marine catastrophes control on the basis of an emergency computing center (ECC) are discussed. Functioning of ECC in real-time mode is provided by the system integration of ontological synthesis of information, algorithmic and software on the basis of database of dynamic measurements and structured knowledge base. The focus is on providing support for decision-making in complex dynamic environments with the use of the modern theory of catastrophes.

Keywords: emergency computing center, an intelligent system, high-performance computing, real-time mode, dynamic theory of catastrophes.

1. Ontological synthesis of ECC models

Integrated development environment (IDE) of ontological synthesis for modeling and visualization of vessel behavior in an emergency situation is formalized on theoretical results [1] - [15] and uses the following models [5] - [7]:

$$Ont = Ont(M) \cup Ont(U) \cup Ont(R) \cup Ont(S) \cup Ont(D), \quad (1)$$

where Ont (M) - metaontology; Ont (U) - ontology for management calculations and modeling; Ont (R) - ontology for restrictions of the role of terms and relations between them; Ont (S) - domain ontology; Ont (D) - ontology of data for calculations and modeling.

With the formalization of the ontology model for domains Ont (S), which are general domain of problem of emergency control Ont (P), the following definitions are used [5], [7]:

Definition 1. Domain ontology

$$Ont(S) \rightarrow \langle Q, C \rangle \in Ont(P) \quad (2)$$

defines a number of terms Q (objects, processes and phenomena) and a plurality of relations C between them:

$$Q = \{q_k | k = 1, \dots, K\}, C = \{c_l | l = 1, \dots, L\} \quad (3)$$

Definition 2. Evaluation model of vessel behavior in an emergency is an interpretive theory in which framework various complex ontology formalisms are developed depending on the problem. The concept of space and time allows to define the basic concepts of the interpretation of vessel behavior on the basis of a dynamic model of catastrophes in the form of mapping [5]:

$$Ont[Cat(D)] = \langle Ont[Cat(B)], Ont[Cat(E, DO)], Ont[Cat(F, DO)] \rangle, \quad (4)$$

where Ont [Cat (B)] - ontology that describes the bifurcation set, Ont [Cat (E, DO)] - ontology of sets that defines the interaction of the system elements "vessel - environment"; Ont [Cat (F, DO)] - ontology of sets of features of interaction dynamics.

Definition 3. The construction of ontological system for the dynamic model of catastrophes within mapping (4) is carried out using the principle of competition [5] - [7]:

$$Ont[Com(PR)] = \langle Ont(ST), Ont(FLM), Ont(ANN) \rangle, \quad (5)$$

where Ont (ST) - ontology of the standard model which describes a state of emergency on the basis of the achievements of classical mathematics; Ont (FLM) - ontology model implemented in the framework of fuzzy logic basis; Ont (ANN) - ontology formalizing neural network model.

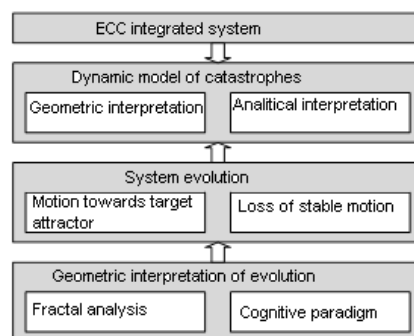

Fig.1. Ontology defining the dynamic model of the interaction system of ECC elements on the basis of the modern theory of catastrophes

Figure 1 presents an ontological system formalizing a dynamic model of the modern theory of catastrophes. It highlights aspects of the ontology defining features of the system behavior and its geometrical interpretation.

Metaontology for interpretation of the evolution of the vessel in an emergency situation. Among the possible conceptual metabasis corresponding to level of metaontology "space - time" in the interpretation of an emergency under the dynamic model of catastrophes can be distinguished [5] - [7]:

$$Ont[META(t)]: Ont - A[W, V, DO], Ont - B[W, V, DO], \quad (6)$$

where, Ont-A [W, V, DO] formalizes features, ratio, mapping; Ont-B [W, V, DO] - state, process, time, and the structure of W, V, DO - environment (interaction space), and a dynamic object.

With the formalization of a dynamic model of catastrophes as evolutionary potential of a self-organizing system the following assertion is justified

$$\forall C \in Ont - A[W, V, DO], [c] is - a [ob] \quad (7)$$

This means that the elements of the concept of "dynamic interaction" $Cat \in C$ (Ont-A [W, V, DO]) are assigned to C-category "object of study", and a generalization of the problem of realization at W, V-model level leads to metadiagramme of interpretation system "Vessel - environment" methods of modern catastrophe theory shown in Fig. 2.

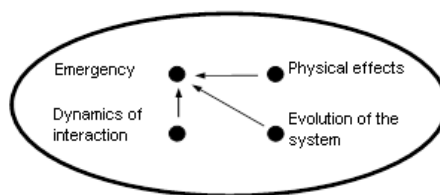

Fig. 2. Metadiagramme defining the generalization of the problem implementation of management strategies in the formalization of the interaction system

Thus, the natural metabasis Ont-A [W,V,DO] sets the object metaontology which language $L(Ont-A [W, V, DO])$ has a logical model in the form of a given implication. The conceptual basis of the Ont-B [W,V,DO] is called "natural" and contains concepts "process", "state" and "time". Therefore, the model structure metabases Ont-B [W,V,DO] are *dynamic* and ontology Ont-B [W,V,DO] is an information system that focuses on the modeling of the

system of interaction of objects in a complex dynamic environment, which determines the state of emergency.

The dynamic system "ship - environment" in a state-space is a model structure that can be made on the basis of the algebraic system so that the logic model of this type of language will be one of the forms of action logic [3].

Thus, formal ontology model of the integrated ECC complex that defines the operation of the dynamic model of catastrophes allows to describe ontologies at different levels of abstraction. Based on this integration intelligent technology of knowledge integration is implemented with the use of ontological system [5]. The formalization of a system of knowledge consists is in the interpretation of the domain S(ES) in the form of structures having a certain semantic location - the spatial, temporal and functional. Considering the semantic space structures of investigated domain knowledge S(ES), it is necessary to carry out their semantic localization [5] - [7].

2. The axiomatic basis of the interaction system dynamics

The main operations which are performed in the ECC software package within information processing paradigm in multiprocessor computing environment [5] - [7] are based on an axiomatic basis [7], which allows to describe the behavior of the interaction system "vessel - environment" in an emergency situation at the level of structural and functional configuration (Figure 3).

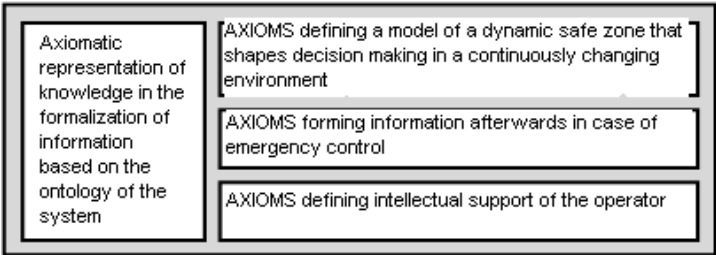

Fig. 3. The axiomatic basis of the system

The principal advantage of this technology is the view of the system evolution on the implementation interval $[t_0, t_k]$ in the form of fractal structures, and the view of interaction dynamics interpretation – using entropy analysis [4]. The result is simplicity and clarity of the mapping an emergency development process in a complex dynamic environment.

Axiomatic knowledge representation. General concepts of axiomatic study of the domain are specific to each applied ontology. In the investigated area axiomatic

representation of knowledge in the interpretation of the system is determined by formalization of information flow through a comprehensive ontology [5], [7] in the following axioms.

Identification axioms are the description of all types of variables and relationships of formalized structure of interaction system:

$$Axiom(Ident) = \langle Var, Rel \rangle \in \Omega(Str), \quad (8)$$

where Var, Rel - variables of the problem and the relationships between them; $\Omega(Str)$ - knowledge of the structure.

planning axioms set the rules of calculations (the order and accuracy conditions). The basis of calculation in the phase space is the interval arithmetic property that allows for the convergence of the iterative procedure of calculation of interval values of parameters for localizing certain intervals containing the required decisions in the interpretation system:

$$Axiom(Plan) = \langle Evol(PH), Int(Cal) \rangle, \quad (9)$$

where Evol(Ph) - the evolution area of the phase space, Int(Cal) - interval arithmetic procedures.

Calculations axioms set the rules for calculating the relationship in the phase space of the system. Calculations axioms also include the optimization axiom.

$$Axiom(Calcul) = \langle Rule(Cal), Axiom(Opt) \rangle, \quad (10)$$

where Rule (Cal) - calculation rules; Axiom (Opt) - optimization axioms to ensure optimal decision-making research tasks, the structure of which is represented as logical axioms tables (Logical Axioms Table).

Thus, axiomatic knowledge representation allows to have modeling procedures support while the interpretation of the evolution of the vessel in a complex dynamic environment of an emergency.

Interaction system "Ship - environment" is developed on the time interval $[t_0, t_k]$, as a sequence of discrete states:

$$S(t) \in S[t_0, t_k] \quad (11)$$

which are formalized under the quasi-stationary hypothesis [6] - [7].

The state space of a fractal system $S(t)$ is defined by an ordered set of fractal mappings. These mappings are a self-similar structure developing in the process of evolution of the system. In general, the fractal ensemble is portrayed as a compact set, presented on the basis of the interpretation of the dynamics of the system in an emergency. The sequence of cycles of evolution takes a fractal system $S(t)$ of the current configuration, which determines the

beginning of its operation in the next state, defining its dynamics in the studied time interval $[t_0, t_k]$.

Stable development system stages $S(t)$ determine the motion of a system of interaction to a target attractor. In this situation, the system remains in a state close to equilibrium, and its organization is undergoing significant changes. At a steady state of the system the external influences are described by means of streaming load, changing the fractal structure F_R depending on the characteristics of the situation. The movement towards the target attractor $S(G, Attr)$ is determined by configuration in such a state of the system:

$$S(G, Attr) \rightarrow Stab(F_R). \quad (12)$$

Stage of the critical state (occurrence of the disaster) is characterized by the release of the test parameters of the system from the specified range and the emergence of bifurcation - the loss of stability of the system which is connected with the formation of alternative options for its organization. Cycles of functioning interaction systems define the process of self-organization $S(G, SO) F_R$ fractal structure in continuous changes to the system dynamics. The system configuration when a loss of stability (the phase transition and the formation of the disaster) is characterized by the condition:

$$S(G, SO) \rightarrow Cap(F_R). \quad (13)$$

Thus, the conditions and their implementation within the framework of a dynamic model of disaster allow to formulate an axiomatic basis and present an emergencies interpretation ontology. Developed on the basis of such a formalization of the ontology model are regarded as components of the overall system problems ontology "vessel - environment" and defines the criteria for CR truth (True) to meet the requirements Dem completeness (Full) and consistency Dem (Non-Contr)] formulated axioms and inference rules:

$$Ont(SAU) = \langle C_R(Truth) [Dem(Full), Dem(Non - Contr)] \rangle. \quad (14)$$

3. Implementation of the axiomatic approach in the analysis of emergencies

Within the framework of the axiomatic approach recognition of abnormal behavior of the ship in an emergency is implemented using the following procedures:

Procedure 1. Classes of abnormal behavior are defined and appropriate reference trajectory with unprecedented knowledge base are investigated.

Procedure 2. The analysis of the observed trajectory which is formed on the basis of fragments close to the classes of non-standard behavior is carried out.

Procedure 3. For selected trajectory fragments the sequence of axioms corresponding to the reference trajectories is defined.

Thus, the problem of recognition of abnormal behavior of the ship in emergency situations, based on ECC is reduced to the problem of fuzzy search of fragments of reference trajectories in the observed system trajectory.

The mathematical theory of the ECC computing system is defined by an object system and a system of relations within the ontological basis, and the logical structure of the interpretation of the dynamics of vessel - based on the fundamental provisions (axioms), determining *the evolutionary complexity* of the system. In such an analysis the analytical structure of the dynamical theory of catastrophes is represented by patterns of behavior and control spaces or a modified system of iterated functions (SIF) [7] and a geometric one – different visual models in the form of cognitive fractal images and maps. The problem of space-time is considered taking into account *the complexity of the measure* in respect of the interaction the ECC elements, communication concept analytical synthesis with physical laws of interaction dynamics.

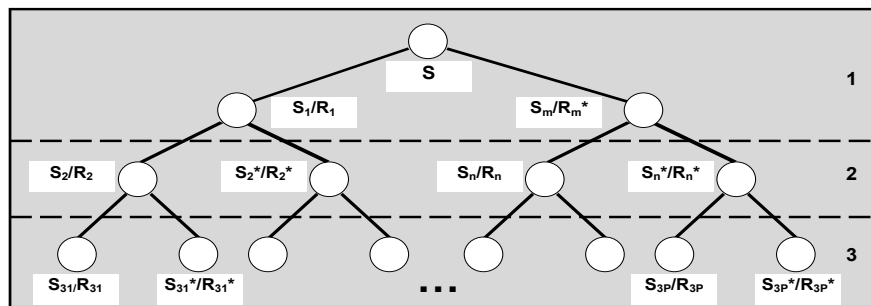

Fig. 4. Wood states of a complex system: S - system components; R - the result;
1 - system; 2 - subsystem; 3 - element

As a result of the processing of information about the dynamics of the vessel with the definitions set forth above, statements and axioms on the interval $[t_0, t_k]$ carried out the operation of interpretation. System approach to the interpretation of the current situation of catastrophe theory methods allow to formalize the process of modeling the dynamics of the vessel and to the interaction space network in *a tree of states* of a complex system (Fig. 4). The forecasting task for the behavior of the ship in an emergency is a chain of transformations:

$$X_1(T, S) \Rightarrow Y_1(Out), \dots, X_n(T, S) \Rightarrow Y_n(Out), \quad (15)$$

where the components $X_1(T, S), \dots, X_n(T, S)$ determines the interpretation of the function at each step of the operation of interpretation and management of the dynamic theory of catastrophes or a modified SIF using the control function, and $Y_1(Out), \dots, Y_n(Out)$ – results of the study of the system specification forecast.

One of the ECC features – *hierarchical organization* which determines the conditions of management in time delays, noise and uncertainty. Strategic planning of operations and conceptual solutions in a hierarchical organization is represented in the form of a dynamic hierarchical network [11] (Figure 5) that displays the result of the integration of a fundamental component of a dynamic model of catastrophes and modified on the basis of the SIF intelligent technology and high-performance computing [7].

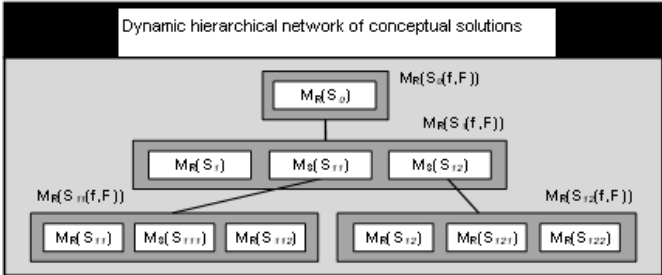

Fig. 5. Structure of the dynamic hierarchical network

The hierarchical model allows us to describe the dynamics of a vessel in an emergency situation at various levels of abstraction: the reflection elements, properties, performance, determining the management and interpretation in the process of development of the situation. When the decomposition is implemented *connectivity concept*, defines a representation of the original model $M_R(S_0)$ in the form of a set of sublevels models of tree-like attitude. Formation of hierarchy is carried out using standard decomposition bases. At any level of the hierarchy ECC subsystems are defined and the relationships between them, while providing the level of the whole, and not lost the finest levels of analysis.

This interpretation of the data shows *the principle of subsidiarity*. According to this the conditions in which a continuous change in the behavior of the vessel are provided. A formal model of information transfer opens up opportunities to find solutions with the use of hierarchical structures characteristic of the investigated tasks. This model does not depend on the contents and the task analysis and is a versatile apparatus for analysis and search for solutions. This opens the possibility of "compression" of information, because of the dynamic measurements only the data is obtained which is required during emergency control.

Thus, the ECC computing complex is regarded as ADS [9] which operates in a complex dynamic environment. System control is in formation of procedures minimizing the objective function for maximum efficiency of the control in the current situation. ECC objects are considered as active elements which functions are aimed at modeling and visualization of vessel dynamics. When generating alternatives, and the development of control actions the

collective strategy selection is carried out, based on the active elements of the strategy of the system. The hypothesis of the independent behavior of active elements of ECC is considered within the paradigm of information processing in a multiprocessor computing environment. Synthesis of the ECC optimum active elements management ensures maximum efficiency of information processing procedures. Many ongoing activities is determined by the decision making procedures. Planning activities in the assessment of the system status and forecasting its development is the choice of effective planning procedures based on optimality criteria.

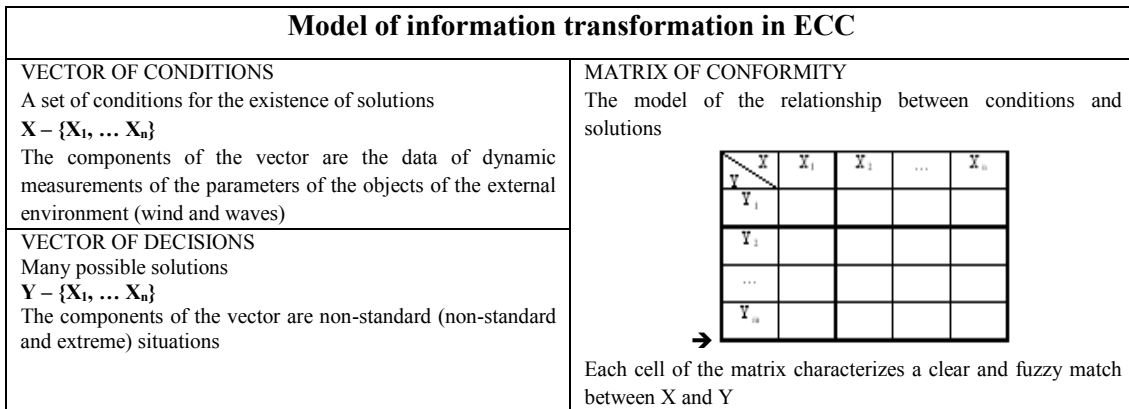

Fig. 6. Model of information transformation in the analysis of the behavior of ship emergency

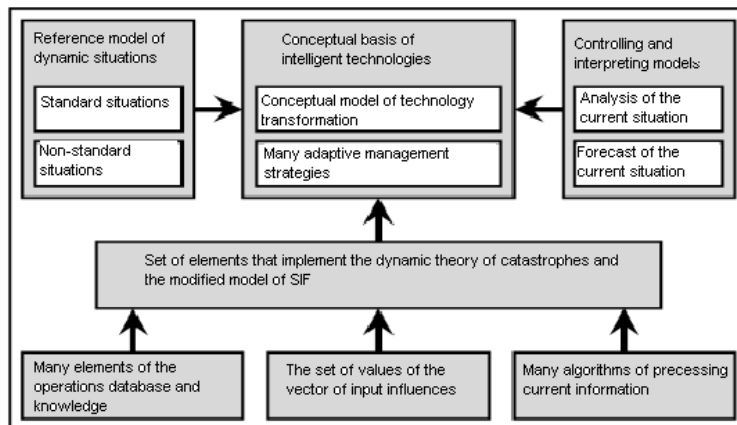

Fig. 7. The conceptual basis of intelligent technologies

the interpretation of the behavior of the ship in case of emergency

Figure 7 presents a conceptual basis of intellectual technologies which implements the information transformation procedure in the interpretation of the behavior of the ship on the basis of the dynamic theory of catastrophes [5] and the modified model of SIF [7].

Model of interpretation of the situation is presented in the form of the interaction field in which the transformation and geometric mapping are carried out allowing to understand the learning and development processes and to identify "subtle effects" of the phenomenon under

study. The cognitive process provides a "compression" of the processed signal and the maximum possible code of abstraction contained in the signal description in order to achieve a higher degree of predictability [5] - [7].

Conclusion

The ontological synthesis of vessel behavior control models in the event of maritime catastrophes provides a solution to the problem of increasing the effectiveness of the decision making process in the operation of the ECC which implements the methods of the dynamic theory of catastrophes. Presented decisions determine a problem of interaction of the ship with the environment on the basis of the axiomatic approach formalizing achievements of intelligent technology and high-performance computing. An adequate description of the hierarchical organization and the identification of the physical laws of the process of interaction in emergency situations is achieved by identifying the essential elements of functionally significant interpretive ECC system. This analysis makes it possible to develop mechanisms of formation of administrative decisions and to module calculations in emergency mode. [14]. Compression of information and the construction of interpretive models are achieved on the basis of the matrix of conceptual solutions, dynamic hierarchical network and the formal apparatus of analysis and forecasting of the behavior of the ship in emergency situations. [5] - [7], [11], [13], [15].

References:

- [1] V.A. Bondarev, Y.I. Nechaev. Center for Operational Control of Maritime Disasters of Ships Commercial Fleet // Izvestia KSTU. №43. 2016, p.207-220.
- [2] On-board intelligent systems. Part 2. Ship systems. - M.: Radio engineering, 2006. Part 3. Systems of ship landing of aircraft. - Moscow: Radio Engineering, 2008.
- [3]. John L. Casti. Large systems: connectivity, complexity and catastrophes. - Moscow: Mir, 1982.
- [4]. V.L. Lazarev. The theory of entropy potentials. - St. Petersburg. Polytechnic Publishing House University, 2012.
- [5] Y.I. Nechaev. Theory of catastrophes: a modern approach to decision-making. - Saint- Petersburg: Art-Express, 2011.
- [6] Y.I. Nechaev, O.N.Petrov. Unsinkability of ships: an approach based on modern theory catastrophes. - St. Petersburg: Art-Express, 2014.
- [7] Y.I. Nechaev. Topology of nonlinear nonstationary systems: theory and applications. - Saint-Petersburg: Art-Express, 2015.

- [8] Y.I. Nechaev. Intellectual technologies in the system of research design. - St. Petersburg: Art-Express. 2017.
- [9] D.A. Novikov DA, S.N. Petrakov. The theory of active systems. - M .: SYNEG, 1999.
- [10] Synergetic paradigm. Variety of searches and approaches. - Moscow: Progress - Tradition, 2000.
- [11] S.V. Smolentsev. Application of a dynamic semantic network for identification in Intelligent Measuring Systems // International Reports Conference on soft computing and measurements SCM-2000. St. Petersburg: 2000. Vol.2, P.82-83.
- [12] V.V. Solodovnikov, V.I. Tumarkin. Theory of complexity and design of control systems. - M .: Science, 1990.
- [13] V.A. Tikhomirov, V.T. Tikhomirov, A.V. Makushkin. The principle of designing information - Probabilistic method of implementing a long-term forecast // Software products and System. №2. 2004, p.10 - 15.
- [14] Urgent Computing Workshop 2007. Argonne National Lab, University of Chicago, April 25-26, 2007. [Electronic resource]: <<http://spruce.teragrid.org/workshop/urgent07.php>>.
- [15] L. Zadeh Fuzzy logic, neural networks and soft computing // Communication on the ASM-1994. Vol.37. № 3, p.p.77-84.